

MOBILIARIO

ESCULTURAS: Acero inoxidable

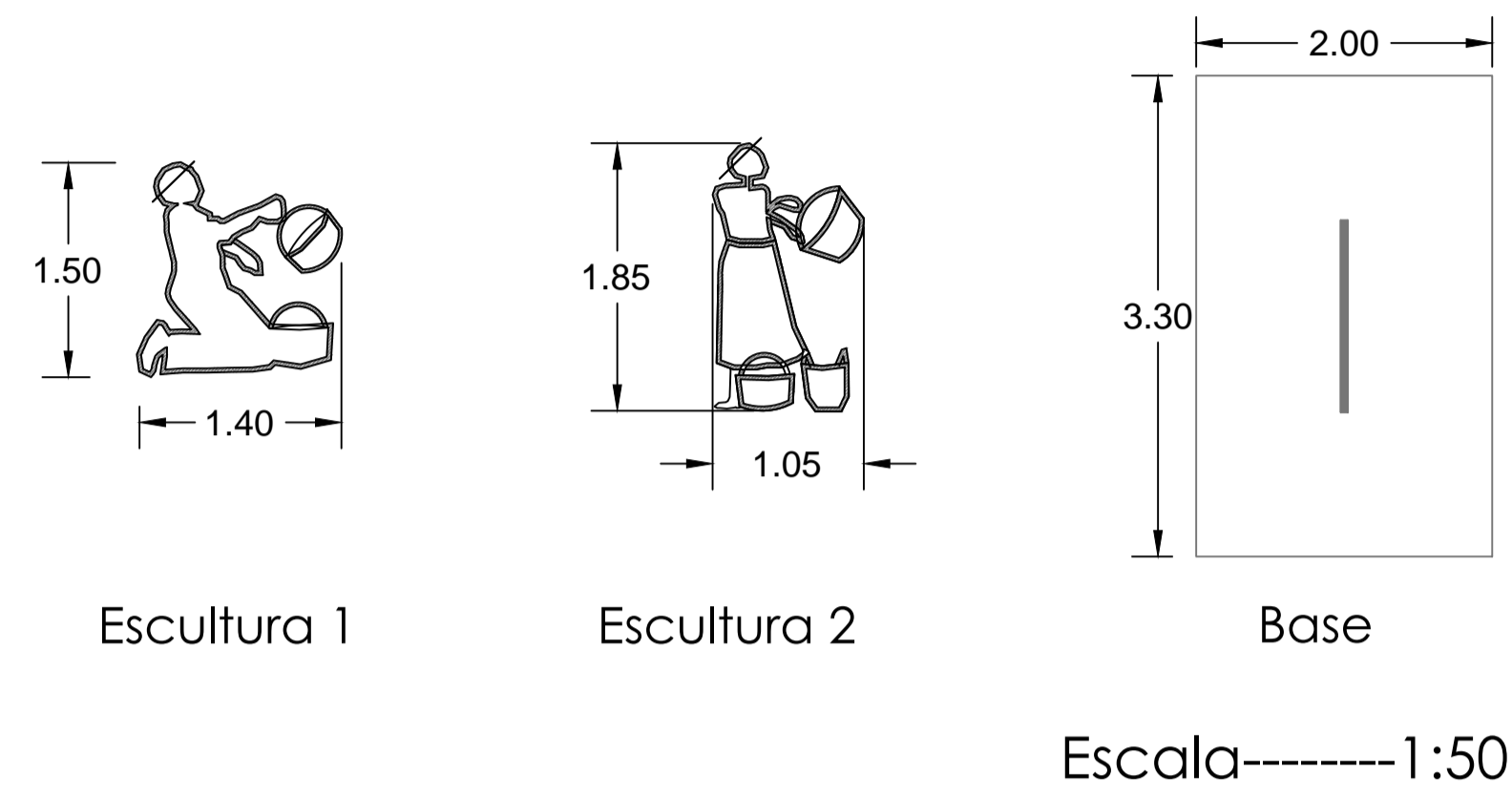

PAPELERAS: Metal galvanizado

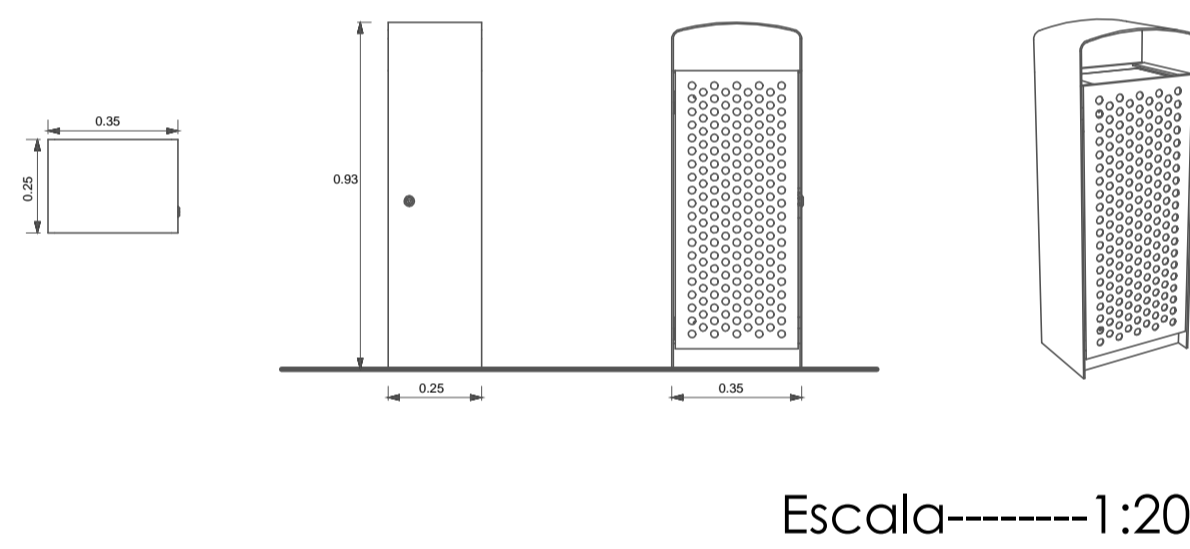

SEÑALETICA VERTICAL: Acero galvanizado

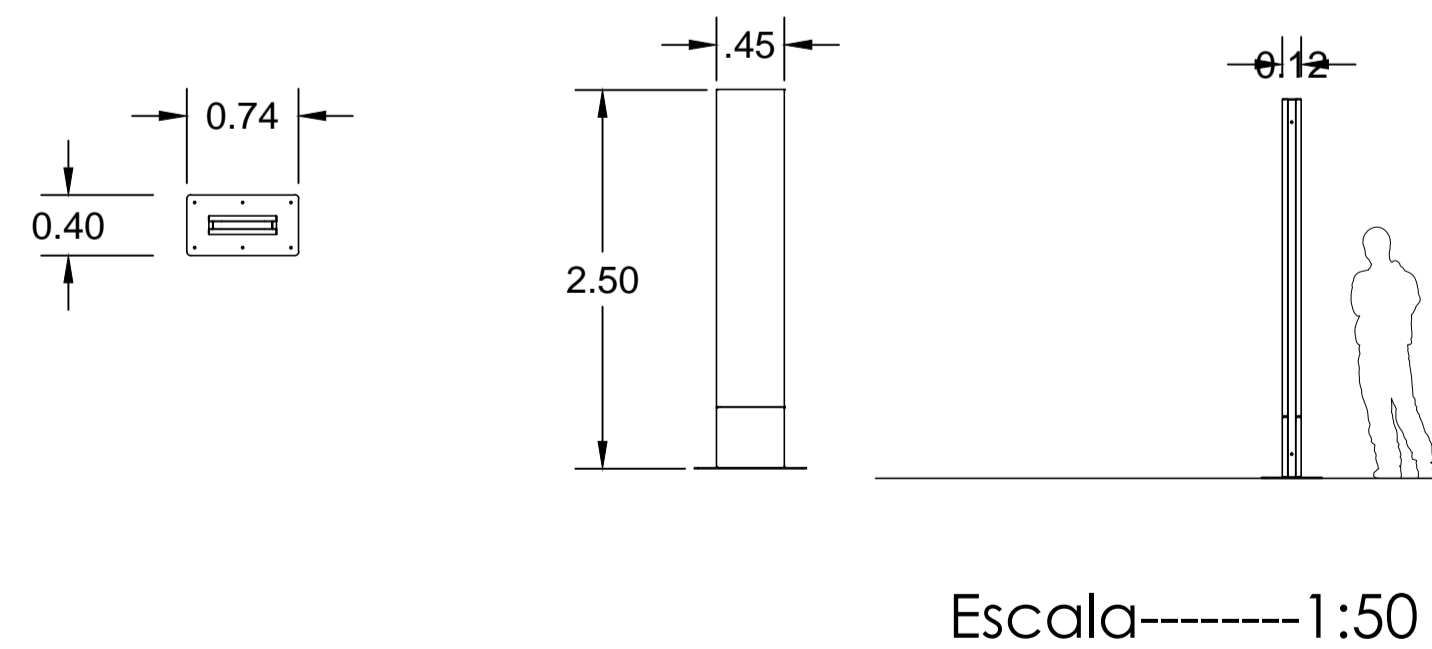

BANCAS: bloque de concreto

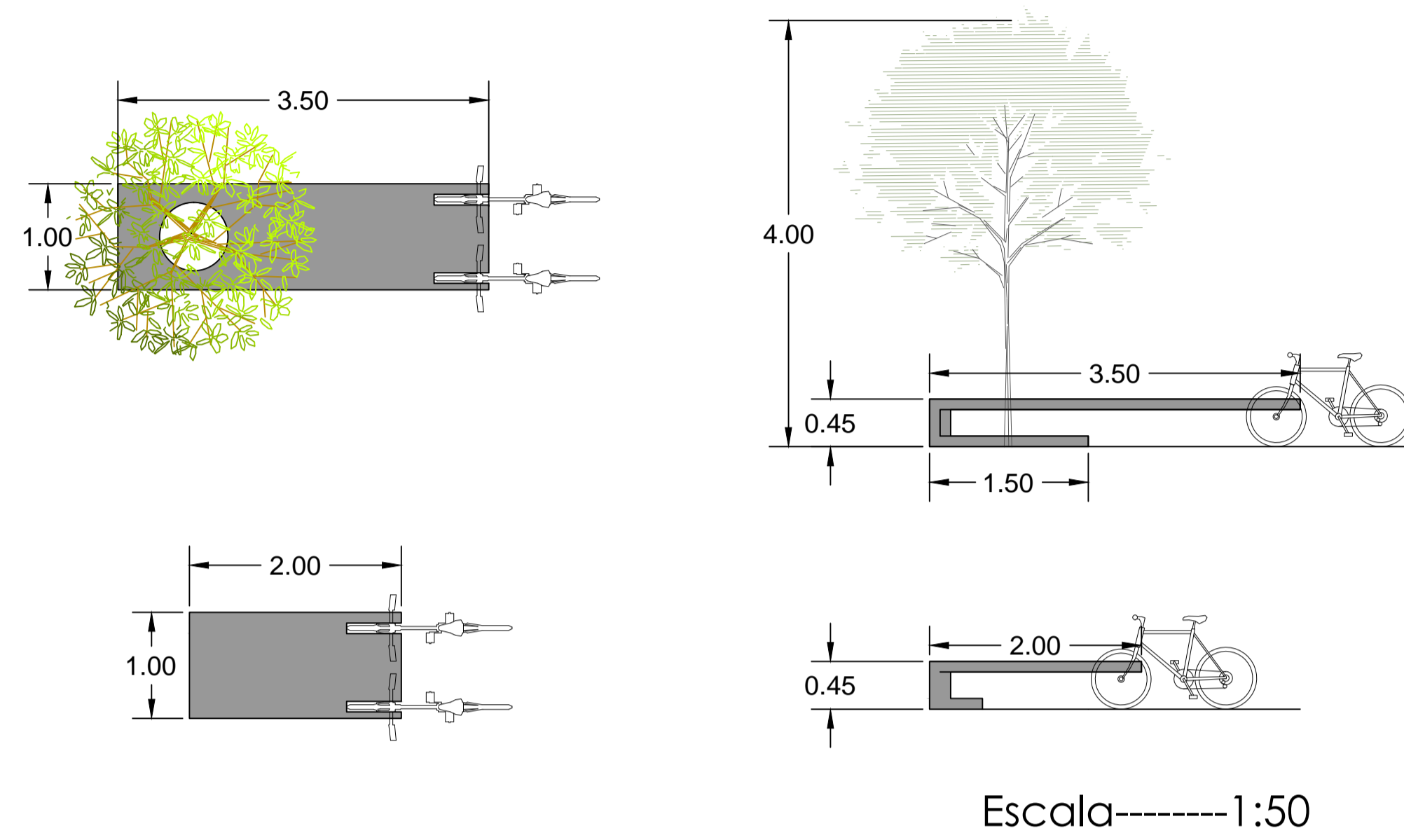

LUMINARIAS:

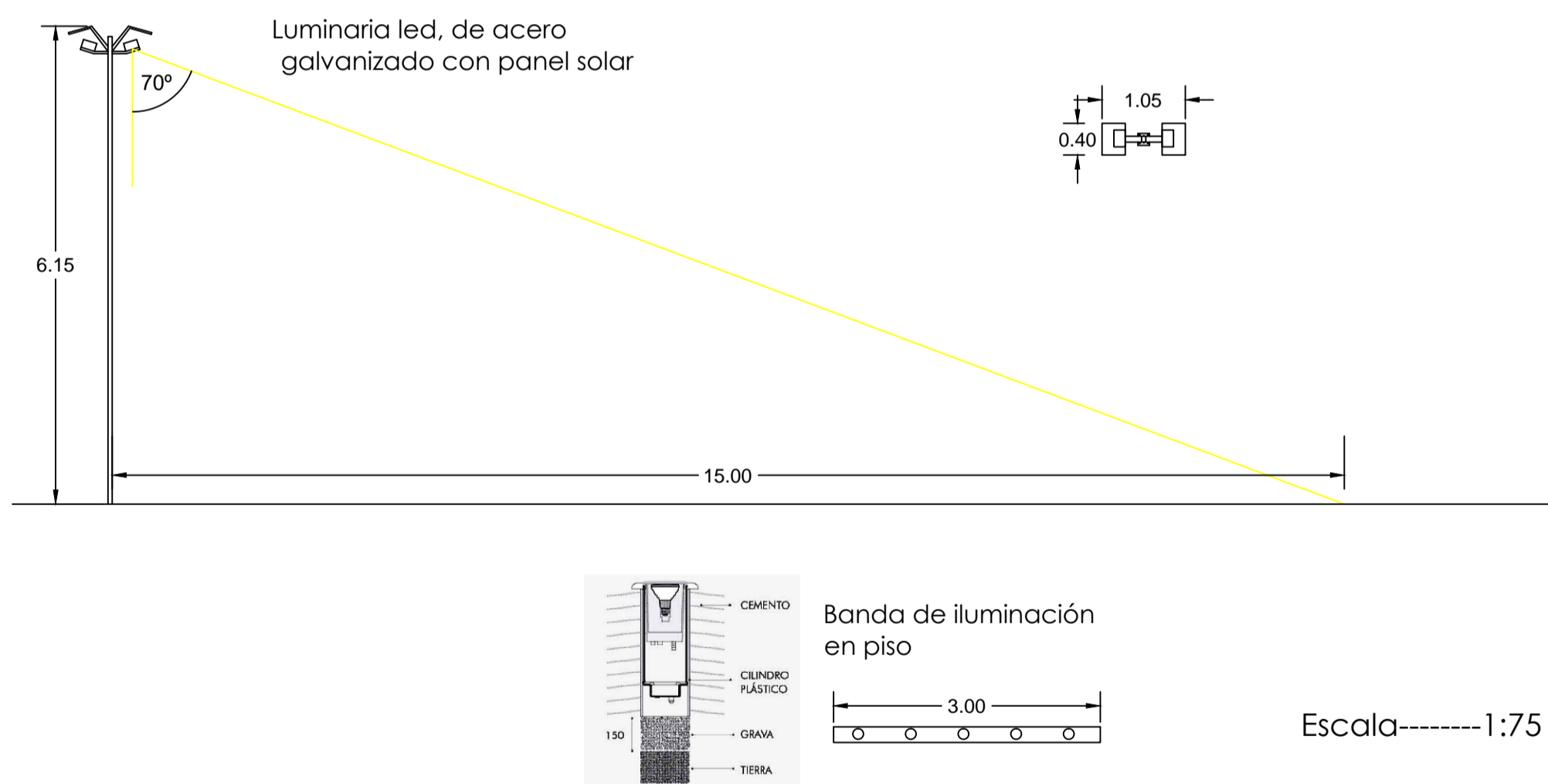

MOJONES: Bloque de hormigón incluye luminaria

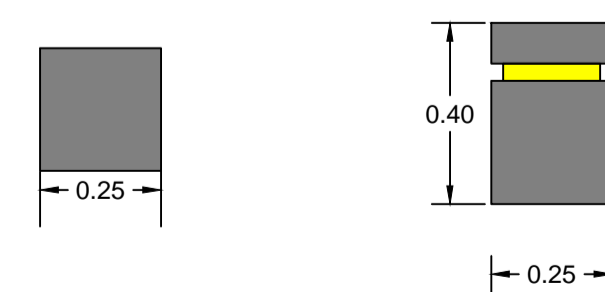

PUERTA BASCULANTE DE EDIFICACIÓN

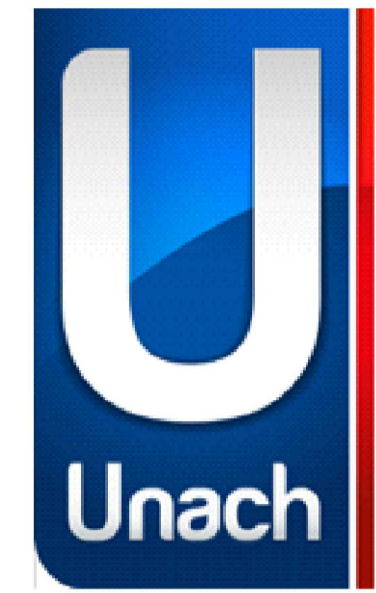

UNIVERSIDAD NACIONAL DE CHIMBORAZO
FACULTAD DE INGENIERÍA
CARRERA DE ARQUITECTURA

TRABAJO DE FIN DE CARRERA
"PLAZA SIMÓN BOLÍVAR"

AUTORA:
MARCELA A. HARO LLAMUCA

DIRECTOR:
ARQ. FREDY RUIZ ORTIZ

CONTIENE:
MOBILIARIO

ESCALA:
INDICADAS

LAMINA:
PLANOS AQUITECTÓNICOS